CLEMENTS



www.evocare.com.au
Ph: 07 3355 8000 Fax: 07 3355 5043
Email: sales@evocare.com.au

proven through performance

Ceevac
High Vacuum High Flow
Portable Suction Pump
SUC 81030
12 VDC | 100-240 V 50/60 Hz



User Manual

Manual No. SUC 81030 008
Issue 1

Safety

Thank you for purchasing this Clements Ceevac High Suction Pump.

For your safety it is imperative that this unit only be operated by authorised personnel in accordance with the instructions as described in this manual. Operated in this way, the Ceevac High Suction Pump will provide the standard of service specified.

Due to continual improvements in product design, the Ceevac High Suction Pump may vary in detail from the descriptions in this manual. In the event of further questions please contact your local distributor or BMDi TUTA Healthcare direct.



Familiarise yourself with these *Directions for Use* before operating this device.

User Manual
Ceevac High Suction Pump
Manual Number SUC 81030 008 Issue 1

Copyright © 2015 BMDi TUTA Healthcare Pty Ltd

The information in this manual was originated by, and is the exclusive property of BMDi TUTA Healthcare Pty Ltd. It is furnished for customer information only, and is not an authorisation or licence to make this product or to furnish this information to others.



BMDi TUTA Healthcare Pty Ltd
Unit 4B, 128-130 Frances Street
Lidcombe NSW 2141 Australia
Phone: +61 2 9466 5300
Website: www.medaust.com

CE 0086

EC	REP
----	-----

Priory Analysts Ltd
The Pinnacle, 160 Midsummer Boulevard
Milton Keynes, MK9 1FF, United Kingdom

Contents

<i>Description</i>	<i>4</i>
<i>Specifications</i>	<i>5</i>
<i>Environmental Conditions</i>	<i>6</i>
<i>Symbols</i>	<i>7</i>
<i>Cautions</i>	<i>9</i>
<i>Controls and Operation.....</i>	<i>10</i>
<i>Battery Status and Charging.....</i>	<i>12</i>
<i>Cleaning</i>	<i>14</i>
<i>Electromagnetic Interference.....</i>	<i>16</i>
<i>Spare Parts</i>	<i>17</i>
<i>Troubleshooting.....</i>	<i>18</i>
<i>Wiring Diagram.....</i>	<i>19</i>
<i>Diagnostic Setup</i>	<i>20</i>
<i>Periodic Safety Check</i>	<i>22</i>
<i>Emissions Guidance Table 201</i>	<i>23</i>
<i>Immunity Guidance Table 202.....</i>	<i>24</i>
<i>Immunity Guidance Table 204.....</i>	<i>25</i>
<i>Warranty.....</i>	<i>26</i>

Description

The Clements Ceevac High Suction Pump is a compact, portable unit designed to suit the needs of hospitals, doctors' surgeries and paramedics in providing a strong source of suction for use in both indoor and outdoor environments where mains power is unavailable or interrupted

Identification

SUC 81030 Ceevac High Vacuum / High Flow Portable Suction Pump

Intended Use

To provide a continuous vacuum source, within the stated operating vacuum range, for the aspiration of fluids and particulate matter in medical procedures carried out by clinically trained and authorized personnel.

Contraindications

Not to be used for thoracic or low vacuum drainage.

Classifications

GMDN	36777
GMDN Term	Suction unit, electric powered
GMDN Synonym	Aspirator
Device Class	Class IIa (Rule 11)
Electrical Protection (on battery)	Internally powered
Electrical Protection (on mains)	Class II
Electrical Protection (on vehicle)	Class II
Protection	Type BF Applied Part
Sterilisation	Not supplied in sterile state
Anaesthetic Rating	NOT Category AP NOT Category APG
Operation Mode	Continuous operation

Specifications

Vacuum	-20 to -80 kPa [-150 to -600 mmHg]
Flow	0 to 25 L/min (through jar)
Mains Power Requirement	100 - 240 V 50/60 Hz 1.5 A
Vehicle Power Requirement	12Vdc 4A
Internal Battery	Fully sealed, rechargeable, lead acid battery. 12 V 4.5 Ah capacity
Battery Run Time	Total 60 minutes unoccluded
Charge / Status Indicator	Light Emitting Diode (LED) lamp on control panel Red / Green / Amber Off / Steady / Flashing Audible beep when LED is red.
Warning time	Minimum 5 minutes
Power Pack / Battery Charge	External; Powers pump. Monitors and charges battery when mains power supply is connected
Pump	Diaphragm type
Filter	Disposable hydrophobic and bacterial filter Retention > 99.999% (0.3 micron)
Collection Container	1 litre autoclavable, shatterproof plastic jar Optional 1 litre disposable liner jar
Overfill Protection	Float valve mechanism
Vacuum Control	Needle valve
Gauge	Bourdon tube type. Dual scale.
Gauge Range	0 to -100 kPa graduated at 5 kPa 0 to -760 mmHg graduated at 50 mmHg
Weight	4.4 kg total including battery and accessories
Dimensions	360L x 215W x 195H mm
Standard Conditions	25°C, Sea level, 100kPa

Package Contents

The Clements Ceevac package contains:

- Ceevac portable suction pump
- Charger with mains power supply lead
- Silicone medical suction tubing
- 1 litre reusable collection jar with bung assembly
- Cigarette lighter 12 volt power lead
- Disposable antibacterial/hydrophobic filter

Environmental Conditions









Environmental conditions for operation, transportation and storage are shown in the following table. In addition, for vehicular transportation, the unit should be kept upright.





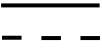
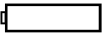



State	Parameter	Minimum	Maximum
Operating	Temperature	5°C	35°C
	Humidity	10% RH	93% RH
	Barometric Pressure	800 hPa	1060 hPa
Transport and Storage	Temperature	-25°C	70°C
	Humidity	0% RH	93% RH
	Barometric Pressure	500 hPa	1060 hPa

Shipping with Internal SLA Battery

- Unrestricted USA shipment.
- Complies with IATA/ICAO Special Provision A67 for air transport.
- Recognised by DOT as “Dry Charge” 49 CFR 171-189 for surface transport.
- Classified per MG Amendment 27 as a non-hazardous material for water transport.

Symbols

	General warning
	Consult user manual
	Type BF Applied Part (suction cannula)
	Insulation Class II (double insulation)
Hz	Mains power frequency
	Direct current
	Battery
	On / Off
	CE Mark in conformity with CE MEDDEV directive 93/42/CEE and subsequent changes
	Manufacturer
	Model / Reference Number

	Lot / Batch Number
	Serial Number
	Fragile
	Keep Dry
	Keep Cool / Keep out of direct sunlight
	Temperature Range
	Atmospheric Pressure Range
	C-Tick Mark
	Dispose of electrical product according to requirements of WEEE directive
IP21	Degree of protection against intrusion by body parts or objects an against ingress by water.
	1st Digit - Penetration of Solids 2 = Protected against solids > Ø 12.5 mm
	2nd Digit - Penetration of Liquids 1 = Protected vertical dripping water

Cautions

Usage

1. Use only for the specified *Intended Use*.
2. Do not use near flammable substances such as oxygen or anaesthetic gases.
3. Home care use is restricted to home carers and physically and mentally competent adults.
4. In home care use, keep accessories out of reach of infants as small parts can present a choking hazard.

Fluids

1. Keep device clear of water and other fluids. Do not handle pump with wet hands.

Electrical

1. Use only the supplied power pack / charger.
2. Confirm that electrical rating of power pack matches that of the mains power. Avoid the use of power boards and extensions.
3. If power pack / charger is used, maintain clear access to the mains power outlet to facilitate disconnection.
4. Place pump clear of patient and other electronic equipment.
5. When not in use, disconnect power pack from power supply.
6. Do not pull cable to remove plug from mains power outlet.

General

1. Check the pump and fittings for damage before each use.
2. Do not use without the bacteria/hydrophobic filter correctly fitted.
3. Switch off pump *immediately* if overflow float valve is actuated.
4. After use, clean and store away from heat, dust and sunlight.

Pump Controls

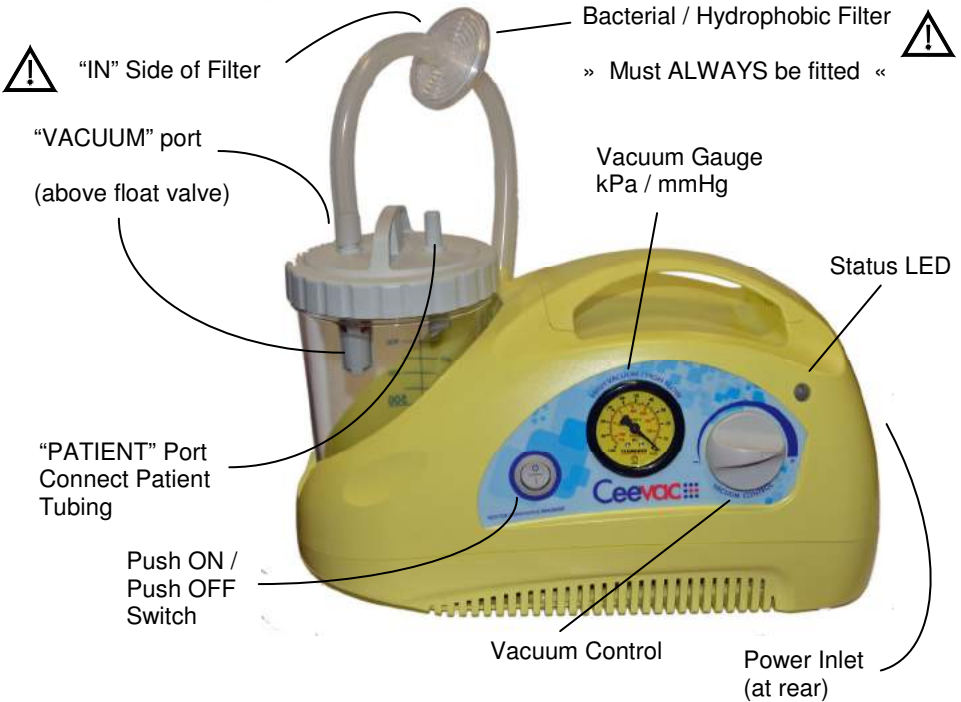

Operation

1. Place the pump on a flat stable horizontal surface.
2. Connect a short length of silicone tubing from the “VACUUM” port to the “IN” side of the bacterial/hydrophobic filter. Connect a short length of silicone tubing from the other side of the filter to the pump inlet.
3. Connect the long silicone tubing to the “PATIENT” port.
4. Select power source.
 - 1) Connect plug of supplied power pack / charger to power socket at rear of pump. *OR*
 - 2) Connect plug of supplied cigarette lighter lead to power socket at rear of pump. *OR*
 - 3) Use internal battery.

5. Press switch to turn on pump. (Press again to turn off.)
6. Occlude tubing and adjust vacuum control to the required vacuum level. (Clockwise = increase)



Always reduce the vacuum level for paediatric and neonatal patients.

7. Apply suction to patient with compatible suction cannula.
8. When finished, switch off pump by pressing switch.

Suction Accessories

The device and its accessories are biocompatible in accordance with EN 60601-1.

Suction Cannulae

Suction cannulae or suction probes for contact with the human body should comply with ISO 10993-1 requirements for biocompatibility.

Collection Jar (Canister)

The mechanical strength of the reusable collection jar (canister) is guaranteed for 30 cycles of cleaning and sterilization. Beyond this, there may be signs of decay and replacement is recommended.

Silicone Tubing

The number of cleaning and sterilization cycles of the silicone tubing is dependent on the actual usage. Tubing should be checked for cracking and other visible signs of wear before re-use.

Battery Status LED

When the pump is connected to external power the tri-colour LED indicates the charging status, either charging or complete.

When the pump is running, the LED indicates the battery status as charged, partially charged or flat.

When not connected to power and the pump is switched off, the LED is off to conserve the remaining battery charge.

LED Colour	LED State	Battery Status	Action
Green	Steady	Charged	Disconnect Charger
Green	Flashing	Charged	
Orange	Steady	Partially Charged	
Red	Steady	Flat	Recharge
Red	Flashing	Completely Flat	Recharge

Audible Alarm

The red status LED is accompanied by a 0.8 second beep repeated at an 8.5 second interval.

Battery Charging

Use only the supplied power pack / charger model UE60-140042SPA1.

Recharge the battery after each use to maintain the pump's maximum standby capacity. When the battery is fully charged the internal charging control circuit automatically reduces current to a trickle charge to compensate for battery self-discharge.

Charging a flat battery takes approximately 240 minutes.

Ceevac may be placed on charge at any time to restore its battery to fully charged condition. It is not necessary to wait until the battery is flat before recharging.

Recharge the battery every three months when pump is not in use in order to maintain the maximum capacity and service life of the battery.

Battery Service Life

The following chart shows the expected service life of the battery against the depth of discharge. In summary, maximum service life of the battery will be obtained from a usage pattern which limits the discharge depth to 30%.

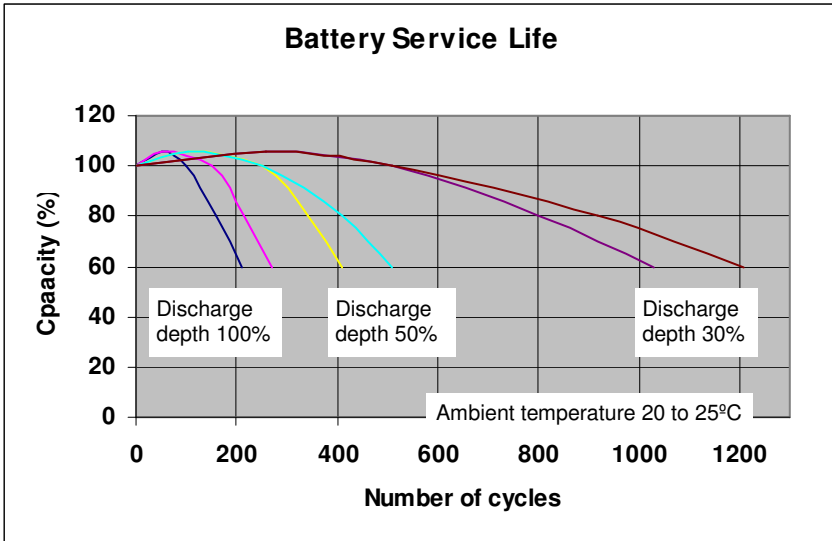

Recycling

The internal SLA battery contains lead. Before disposing of pump, remove the internal battery and recycle according to local recycling requirements for lead products.

Cleaning

After Each Operation

Empty Collection Jar

To empty collection jar disconnect tubing from pump side and remove jar from pump. Remove lid from jar and dispose of aspirated fluid according to local protocols for potentially biohazardous waste.

Clean

Housing

Wipe clean with a damp soapy cloth. Do not immerse or allow liquid to enter the housing. Do not use abrasive cleaning agents.

Suction Tubing

Suction Tubing should be sterilised with sterilants determined by local protocols and compatible with silicone tubing. Suction tubing may be autoclaved to a maximum of 121°C for 15 minutes. At higher temperatures the suction tubing will discolour and lose shape.

Collection Jars

Place jars upright or up-side-down in autoclave: **not on their sides**. Autoclave to a maximum of 121°C for 15 minutes. Do not use phenolic solutions as disinfecting agents in polycarbonate jars.

Bung (Lid)

Unlock bayonet on float cage by rotating cage *clockwise*. Disconnect float cage and float from bung (lid) and separate seal from bung (lid). Place all items upright or up-side-down in autoclave: **not on their sides**. Autoclave all items to a maximum of 121°C for 15 minutes.

Check Bacteria Filter

The bacterial/hydrophobic filter is an important device to help protect the pump and environment from moisture and bacteria taken from patient airways. Clements recommend that the filter be changed every month or when damp or discoloured.

Change after every use when the unit is used on infectious patients.

After Every 100 Hours or 2 Months of Operation

- Check all suction tubing and replace if it is perished, soft or discoloured. Also check the tubing nipples.
- Check the seal ring on the lid and replace if hard, cracked or perished. Check the fit of the lid in the collection jar (canister).
- Check the overflow cut off valve seal and replace if perished or damaged.

Waste Materials

The contents of the collection jars, suction tubing, bacteria filter, internal exhaust filter may contain biohazard wastes. Handle using safe handling procedures, which may include the use of rubber gloves and eye protection, and dispose of according to local protocols for biohazard materials.

Recycling

At the end of their service life, the pump and accessories should be dismantled if necessary, and disposed of according to the WEEE directive.



Electromagnetic Interference

This equipment generates, uses and can radiate radio frequency energy and, if not installed and used in accordance with the instructions, may cause harmful interference to radio communications. However, there is no guarantee that interference will not occur in a particular installation. If this equipment does cause harmful interference to radio or television reception, which can be determined by turning the equipment off and on, the user is encouraged to try to correct the interference by one or more of the following measures:

- Reorient or relocate the receiving antenna.
- Increase the separation between the equipment and the receiver.
- Connect the equipment into an outlet on a circuit different from that to which the receiver is connected.
- Consult the dealer or an experienced radio/TV technician for his or her help.

Changes or modifications to the equipment not expressly approved by Clements could void the user's authority to operate the equipment.

Spare Parts

SUC 81030 001	Kit, 1L Reusable Collection Jar (Pack 1)
SUC 81030 002	Kit, 1L Disposable Liner and Support Jar (Pack 1)
SUC 81030 004	Kit, 2L Disposable Liner and Support Jar (Pack 1)
SUC 81030 008	User Manual for SUC81030 Ceevac Suction Pump
SUC 81030 009	Kit, Seal, Lid, 1L Reusable Jar (Pack 2)
SUC 81030 010	Kit, Lid Assembly for Ceevac
SUC 81030 011	Power Pack/Charger for Ceevac
SUC 81030 012	Kit, Filter Bacteria/Hydrophobic (Pack 10)
SUC 81030 013	Kit, Silicone Tubing Set, Joiner (Pack 1)
SUC 81030 014	PCBA, Electronic Control for Ceevac
SUC 81030 015	Battery, SLA 12V 4.5Ah for Ceevac
SUC 81030 016	Adapter, Vehicle, 12V, Fused for Ceevac
SUC 81030 017	Switch, ON/OFF for Ceevac
SUC 81030 018	Kit, Vacuum Control for Ceevac
SUC 81030 020	Gauge, Vacuum 0-100 kPa for Ceevac
SUC 81030 021	Kit, Float and Cage for 1L Reusable Jar (Pack 2)
SUC 84500 121	Kit, 1L Disposable Liner (1L Disposable Liner) (Pack 50)
SUC 84500 122	Kit, L Disposable Liner (2L Disposable Liner) (Pack 50)
SUC 84500 131	Kit, Support Jar for 1L Liner (Support Jar) (Pack 2)
SUC 84500 132	Kit, 2L Disposable Jar (2L Support Jar, Liner) (Pack 2)

Troubleshooting

1. The Pump Fails To Operate

- If attempting to run from mains power supply:
 - ◆ Check that the mains power supply lead is firmly connected and that the power is on at the mains power supply outlet.
- If attempting to run from the internal battery, check the Battery Status LED on the Control Panel. If it is on (Red) refer to the Charging the Internal Battery section.
- Ensure that the Vacuum Gauge on the Control Panel indicates zero. If not, release vacuum and switch pump off and on.

2. Pump Running But No Vacuum

- Check that all fittings are connected tightly.
- Turn the vacuum controller knob on the control panel and watch the indicator on the vacuum gauge.
- Ensure that the silicone medical suction tubing is in good condition and not old and cracked.
- Check the type of handpiece in use as some handpieces require finger occlusion to assist suction.
- Check bacteria/hydrophobic shut off valve filter.

If the pump fails to work and you are unsure why, please contact your service department or return unit to your distributor.

Wiring Diagram

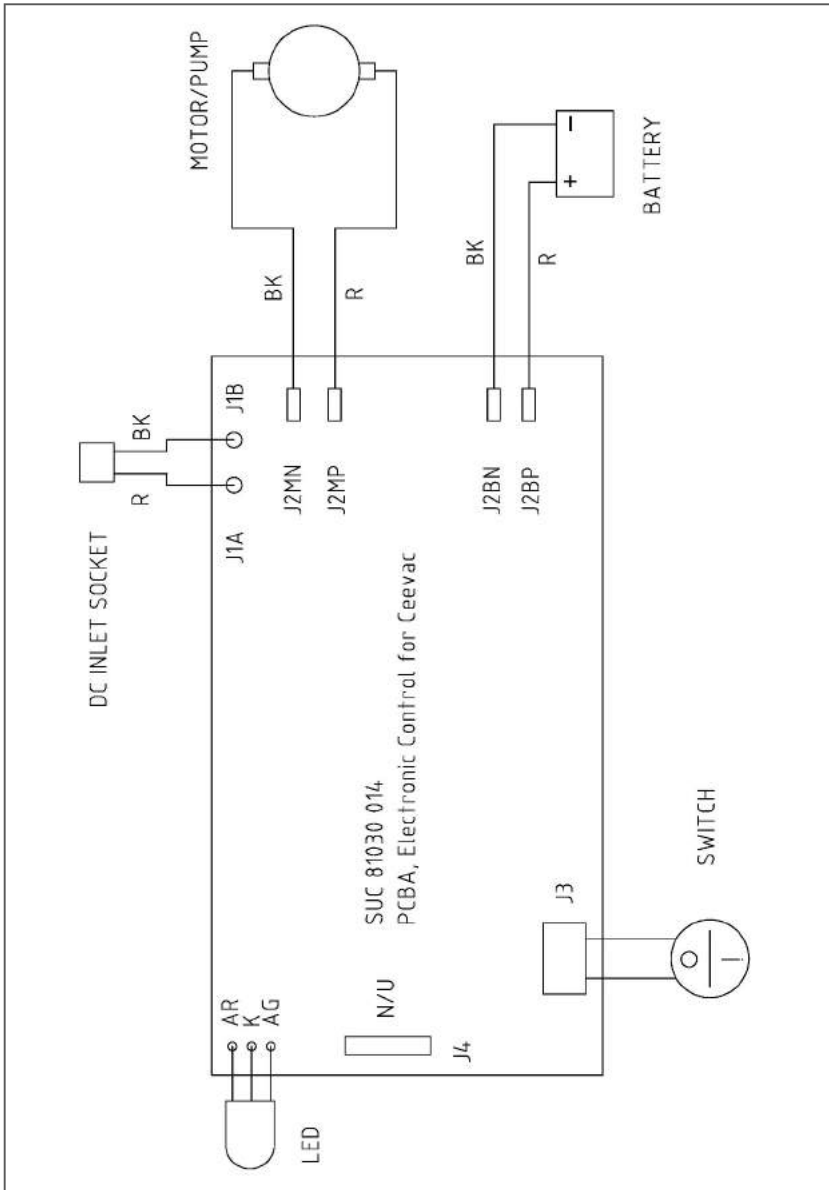

Setup for Diagnostic and Performance Testing

Note that the following arrangements are not used for actual suctioning applications. They are specified to remove unnecessary variations when diagnosing faults and as a standard setup for performance measurement.

Vacuum Check

1. Unoccluded - zero check

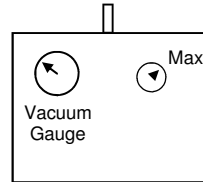

Disconnect all items from inlet and with pump switched off, confirm that gauge reads zero. A non-zero reading indicates a faulty gauge.

Set vacuum control knob to maximum, switch on pump and confirm that gauge reads zero. A non-zero reading indicates obstruction in internal tubing or connections.

2. Occluded - vacuum check

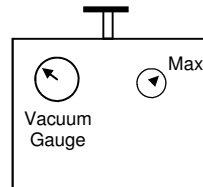

Switch on pump and occlude inlet. Note maximum vacuum reading.

3. Occluded - gauge check

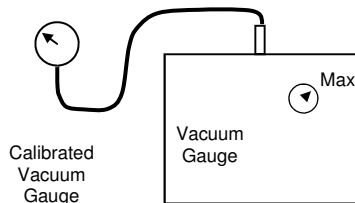

Connect a calibrated vacuum gauge directly to inlet and repeat maximum vacuum reading.

Confirm that pump gauge reads within the specified tolerance.

Flow Check

1. Occluded - leak check

Jar: SUC 81099 (1 litre)
 or SUC 80312 (2 litre)
 Tubing: SUC 80297 (8x13mm)

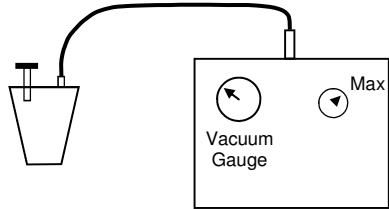

Connect pump as shown in diagram. Set vacuum control knob to maximum, and switch on pump. Occlude jar inlet and confirm that pump achieves the same maximum vacuum as in the previous vacuum check setup. Any difference indicates leaks in jar or connections.

2. Unoccluded - flow check

Jar: SUC 81099 (1 litre)
 or SUC 80312 (2 litre)
 Tubing: SUC 80297 (8x13mm)

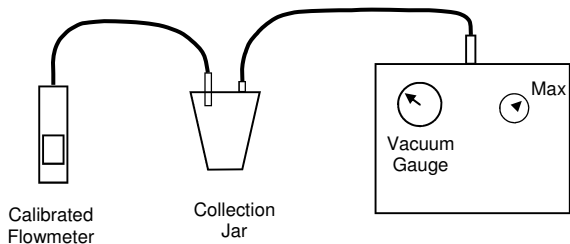

Connect pump as shown in diagram. Set vacuum control knob to maximum, and switch on pump. Connect jar inlet to calibrated flow meter and note flow reading. If flow is significantly below specification, check internal tubing and pump itself (or internal shutoff valve if fitted).

IMPORTANT

**There are no user-serviceable components inside.
Maintenance must be carried out by qualified
personnel only.**

Periodic Safety Check

The following safety checks should be performed at least every 12 months by a qualified person who has adequate training, knowledge, and practical experience to perform these tests.

- * Inspect the equipment and accessories for mechanical and functional damage.*
- * Inspect the safety relevant labels for legibility.*
- * Verify that the device functions properly as described in the instructions for use.*

EMC Information Tables per EN60601-1-2:2001-09 Section 6.

In accordance with EN 60601-1-2:2001 Medical electrical equipment - Part 1-2: General requirements for safety - Collateral standard: Electromagnetic compatibility - Requirements and tests

- 1) "Medical Electrical Equipment needs special precautions regarding EMC and needs to be installed and put into service according to the EMC information provided in the Accompanying Documents" (the following tables).
- 2) "Portable and Mobile RF Communications Equipment can affect Medical Electrical Equipment."
- 3) "The equipment or system should not be used adjacent to or stacked with other equipment and that if adjacent or stacked use is necessary, the equipment or system should be observed to verify normal operation in the configuration in which it is used."

The following tables provide information regarding the EMC characteristics of this Medical Electrical Equipment.

The performance of all functions of the Ceevac suction pump are considered essential performance for the purpose of electromagnetic immunity.

Table 201 — Guidance and manufacturer’s declaration - electromagnetic emissions - all equipment and systems

Guidance and manufacturer’s declaration - Electromagnetic emissions		
The Ceevac suction pump is intended for use in the electromagnetic environment specified below. The customer or user of the Ceevac suction pump should assure that it is used in such an environment.		
Emissions Test	Compliance	Electromagnetic environment - guidance
Irradiated / Conducted Emissions CISPR11	Group 1	The Ceevac suction pump uses RF energy only for its internal functioning. Its RF emissions are very low and will not cause in proximity of any electronic appliance.
Irradiated / Conducted Emissions CISPR11	Class B	The Ceevac suction pump is suitable for use in all establishments, including domestic establishments and those directly connected to the public low-voltage power supply network that supplies buildings used for domestic purposes.
Harmonic Emissions IEC 61000-3-2	Class A	
Voltage fluctuations / flicker emissions IEC 61000-3-3	Complies	

**Table 202 — Guidance and manufacturer’s declaration - electromagnetic immunity
- for all equipment and systems**

Guidance and manufacturer’s declaration – Electromagnetic Immunity			
<p>The Ceevac suction pump is intended for use in the electromagnetic environment specified below. The customer or the user of the Ceevac suction pump should assure that it is used in such an environment.</p>			
Immunity Test	Level indicated by EN 60601-1-2	Compliance Level	Electromagnetic environment - guidance
Electrostatic discharge (ESD) EN 61000-4-2	± 6kV on contact ± 8kV in air	The device doesn't change its state	Floors should be wood, concrete or ceramic tile. If floors are covered with synthetic material, the relative humidity should be at least 30%.
Electrical fast transient / burst EN 61000-4-4	± 2kV power supply lines ± 1kV for input / output lines	The device doesn't change its state	Mains power quality should be that of a typical commercial environment or hospital.
Surge EN 61000-4-5	± 1kV differential mode	The device doesn't change its state	Mains power quality should be that of a typical commercial environment or hospital.
Loss of voltage, brief voltage interruptions and variations EN 61000-4-11	5%UT (>95% dip UT) for 0.5 cycle 40%UT (>60% dip UT) for 5 cycle 70%UT (>30% dip UT) for 25 cycle <5%UT (>95% dip UT) for 5 sec	-	Mains power quality should be that of a typical commercial environment or hospital. If the user of the Ceevac suction pump requests that the appliance operates continuously, the use of a backup supply is recommended.
Magnetic field EN 61000-4-8	3A/m	The device doesn't change its state	The power frequency magnetic field should be measured in the intended installation location to assure that it's sufficiently low.
Note UT is the nominal value of the power supply voltage			

Table 204 — Guidance and manufacturer’s declaration - electromagnetic immunity - for equipment and systems that are NOT life-supporting.

Guidance and manufacturer’s declaration – Electromagnetic Immunity			
The Ceevac suction pump is intended for use in the electromagnetic environment specified below. The customer or user of the Ceevac suction pump should assure that it is used in such an environment.			
Immunity Test	Level indicated by EN 60601-1-2	Compliance Level	Electromagnetic environment - guidance
Conducted Immunity EN 61000-4-6	3Vrms 150kHz to 80MHz (for non life-supporting devices)	$V1 = 3 \text{ V rms}$	The portable and mobile RF communication devices, including cables, must not be used closer to the Ceevac suction pump, than the separation distance calculated by the equation applicable to the transmitter frequency. $d = [3.5/V_1]\sqrt{P}$ $d = [12/E_1]\sqrt{P}$ 80 MHz to 800MHz $d = [23/E_1]\sqrt{P}$ 800 MHz to 2.5GHz where P is the maximum output power rating of the transmitter in watts (W) according to the transmitter manufacturer and d is the recommended separation distance in metre (m). Field strengths from fixed RF transmitters, as determined by an electromagnetic site survey, should be less than the compliance level in each frequency range. Interference may occur in the vicinity of equipment marked with the following symbol. 
Radiated Immunity EN 61000-4-3	3V/m 80MHz to 2.5GHz (for non life-supporting devices)	$E1 = 3 \text{ V / m}$	
<p>Note 1: At 80 MHz and 800 MHz the interval with the highest frequency is applied.</p> <p>Note 2: These guide lines may not be applicable in all situations. The electro-magnetic propagation is influenced by the absorption and by reflection from buildings, objects and people.</p> <p>The field intensity for fixed transmitters such as the base stations for radiotelephones (mobile and cordless) and terrestrial mobile radio, amateur radio devices, radio AM and FM transmitters and TV transmitters cannot be theoretically and accurately foreseen. To establish an electro-magnetic environment generated by fixed RF transmitters, an electro-magnetic study of the site should be considered. If the field intensity measured in the place where the device will be used surpasses the above mentioned applicable level of conformity, the normal functioning of the device should be monitored. If abnormal performance arises, additional measures such as changing the device’s direction or positioning may be necessary.</p> <p>The field intensity on an interval frequency of 150 kHz to 80 MHz should be less than 3 V/m.</p>			

Warranty

BMDi TUTA Healthcare Pty Limited ("BMDi TUTA Healthcare") warrants that this product is free from defects in workmanship and materials for a period of 24 months (3 months for batteries) from the date of shipment by BMDi TUTA Healthcare or its authorised agent to the purchaser. Subject to the conditions of this warranty, if the product fails to operate for any reason within the warranty period and the product is returned to the place of purchase at the purchaser's expense, BMDi TUTA Healthcare will repair or replace the product free of charge.

If a valid warranty claim is made within 30 days from the date of shipment, then BMDi TUTA Healthcare will also reimburse the purchaser for reasonable freight costs in returning the product to the place of purchase.

Conditions of Warranty

1. The product must be returned to the place of purchase with proof of purchase.
2. This warranty is only available to the original purchaser of the product.
3. The product must not have had its serial number removed, defaced or changed, its casing opened, its power supply altered or have been tampered with in any other way.
4. This warranty does not cover :
 - inadequate or incorrect site preparation;
 - improper installation;
 - connection to the wrong voltage;
 - failure of the product due to misuse;
 - the use or operation of the product outside of the physical, electrical or environmental specifications of the product;
 - use in a manner or environment in which the product is not designed to be used;
 - improper adjustment, calibration or operation by the purchaser;
 - the use of accessories including consumables, hardware or software which were not manufactured or approved in writing by BMDi TUTA Healthcare;
 - any modifications of the product which were not authorised in writing by BMDi TUTA Healthcare;
 - any contamination or leakages caused or induced by the purchaser; and
 - inadequate or improper maintenance of the product.
5. This warranty does not cover normal wear and tear.
6. BMDi TUTA Healthcare will not be responsible for damage or loss caused

during shipping.

7. In Australia, apart from any warranties implied by the Trade Practices Act 1974 all other warranties expressed or implied and whether arising by virtue of statute or otherwise are hereby excluded.
8. Outside Australia, all other warranties expressed or implied and whether arising by virtue of statute or otherwise (including any warranties implied by the Vienna Convention) are hereby excluded.
9. BMDi TUTA Healthcare' obligations under this warranty are limited to the repair or replacement of the product, within the terms of this warranty and the total liability of BMDi TUTA Healthcare for loss or damage of every kind whether arising pursuant to the terms of the sale of the product or otherwise in connection with the product is limited to the amount paid by the purchaser to BMDi TUTA Healthcare for the product.
10. Apart from any liability imposed by Part VA of the Trade Practices Act, BMDi TUTA Healthcare accepts no other liability for any loss or damage occasioned (including consequential loss or damages) in any way as a result of the use of the product.
11. The warranty does not extend to cover damage to the following parts as they are inherently prone to wear :
 - motor brushes
12. This warranty does not extend to cover corrosion due to any cause nor to any damage to painted or anodised surfaces.
13. BMDi TUTA Healthcare will give the purchaser the benefit of any manufacturer's warranty in respect of any components in the product which were not manufactured by BMDi TUTA Healthcare, if such a manufacturer's warranty is available.